



ACESSÓRIOS DIVERSOS

DIVERSOS
DIVERSOS
DIVERSOS

CENTRAL DE VENDAS

Alessandra	(11) 95456-6290	vendas@supersoldas.com.br
Andreia	(11) 94538-8656	andreia@supersoldas.com.br
Carla	(11) 95796-0176	carla@supersoldas.com.br
Evelyn	(11) 95804-9330	evelyn@supersoldas.com.br
Fabiana	(11) 97895-9270	fabiana@supersoldas.com.br
Fernanda	(11) 95968-7415	fernanda@supersoldas.com.br
Jamile	(11) 97895-8886	jamile@supersoldas.com.br
Ketlyn	(11) 95824-7581	ketlyn@supersoldas.com.br
Tairine	(11) 97835-4633	tairine@supersoldas.com.br

90000/

Cobalt / Onix

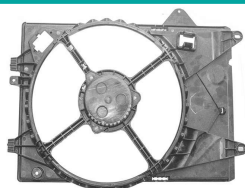

90003/

Uno Vivace/ Palio
Siena S/ Ar Similar Denso

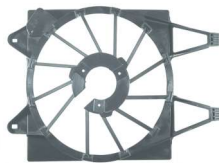

90004/

Gol G5 S/ Ar



90005/

Palio Fire C/S Ar / Idea
C/ Ar Similar Valeo

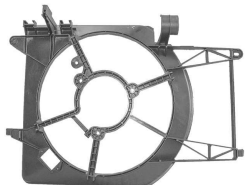

90006/

Palio Fire C/ Ar / Idea C/ Ar
Suporte G Similar Behr

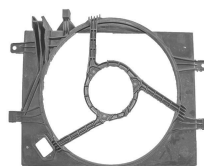

90007/

Palio Fire S/ Ar
Suporte G Similar Behr

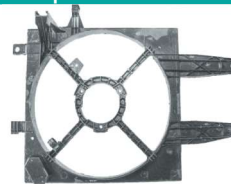

90008/

Celta Antigo C/ Ar

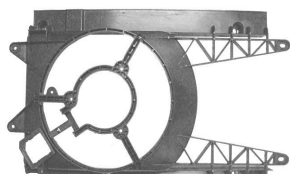

90010/

Palio 1.0



90011/

Corsa / Montana C/ Ar

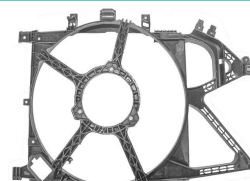

90012/

Condensador HRV 2016>
New Civic 2012/2015



90016/

Palio / Idea Fire C/S Ar
Similar Bosch



90020/

Palio 1.5 S/ Ar

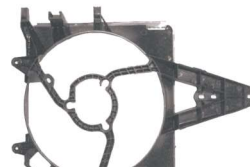

90021/

Celta S/ Ar Similar Valeo

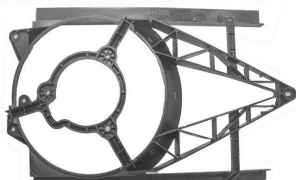

90022/

New Civic 1.8 06/11

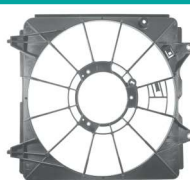

90030/

Palio 1.5 C/ Ar



90031/

Vectra C/ Ar

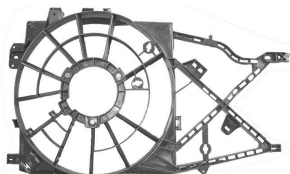

90032/

Corsa S/ Ar

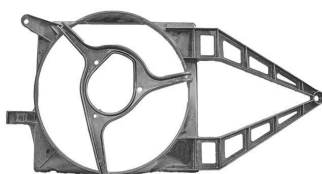

90033/

Corsa Classic



90034 / Celta / Prisma

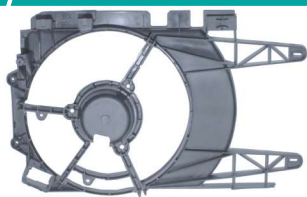

90035 / Fiesta S/ Ar



90036 / Astra

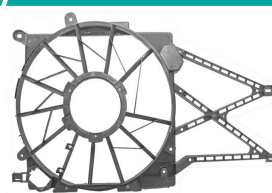

90037 / Gol G5 C/ Ar

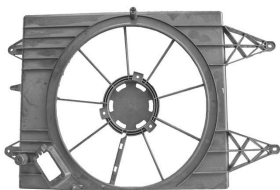

90038 / Uno C/ Vaso Médio Similar Denso

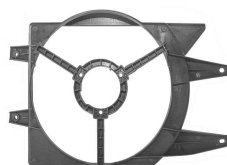

90048 / Uno Fire Similar Valeo

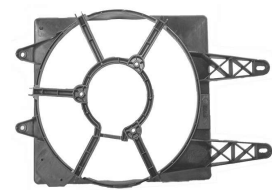

90049 / Fiesta / Ecosport Similar Valeo

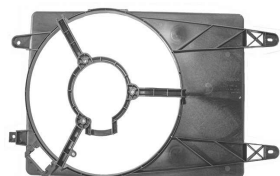

90053 / Uno Vivace / Palio / Siena Similar Denso C/ Ar



90057 / Uno Fire C/ Ar Similar Valeo 03/13

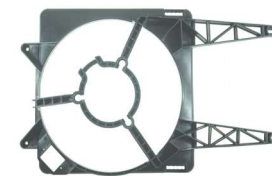

90088 / Vectra / Astra 2010 C/ Ar



90089 / Corsa/Montana C/ Ar 2008



90092 / Gol / Parati / Saveiro C/ Ar G2 / G3 / G4

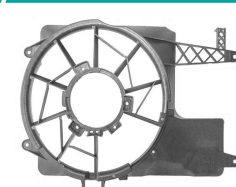

90093 / Gol / Parati / Saveiro S/ Ar G2 / G3 / G4

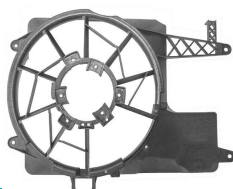

90094 / New Civic 12/16



90095 / Condensador Corsa Classic



90096 / Sandero / Logan / Megane / Kangoo / Symbol



90723 / Fit (Água)



90725 / Condensador New City / New Fit



90732 / New Fit / WRV 15/20
Água



90733 / New Fit / WRV 15/20
Ar Condicionado



90734 / New City 15/20
Ar Condicionado

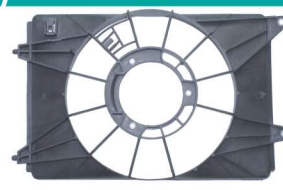

90735 / New City 15/20 - Água



90750 / Novo Ecosport / Ka Novo
New Fiesta

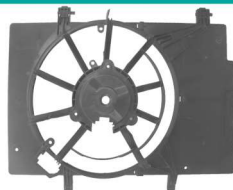

90751 / HRV 2016

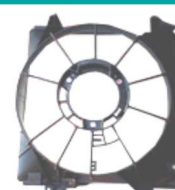

90753 / Kwid 1.0 2017

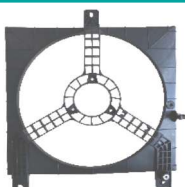

90755 / 206/207 C/Ar 01/04



90782 / Hb20 1.0 20/22
C/ Reservatório



90922 / Palio Fire Similar Behr
C/ Ar Suporte P

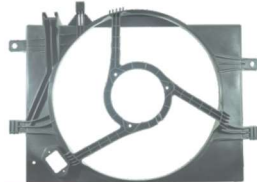

90923 / Palio Fire Similar Behr
S/ Ar Suporte P

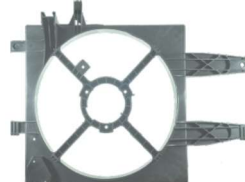

90940 / Agile / Montana
10> C/ Ar



90941 / Corsa Classic C/ Ar
01/10 Motor G



90943 / Argo / Cronos 1.0
17/21 C/ Ar



90945 / Strada 1.3 / Uno 2017>



90946 / Strada 1.4 2017>



90972 / Polo / Fox C/ Ar
03/07 Duplo

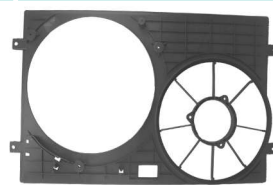

90982 / Hb20 / Veloster 00>



90991 / Corolla 2.0 09/18 C/ Ar

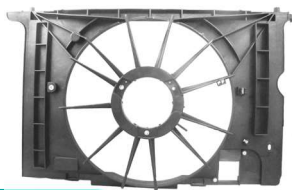

99720 / Corsa Classic C/ Ar
01/10 Motor P



99721 / Fit Antigo
Condensador

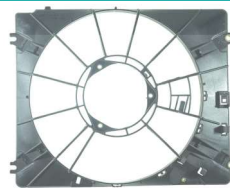

99722 / Corsa / Montana
S/ Ar

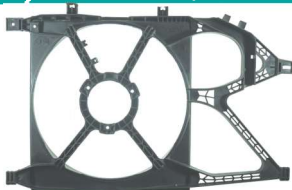

99723 / Suporte Frontal Superior
Defletor/Radiador Corolla 1.8



99731 / City / New Fit
08/14 Água

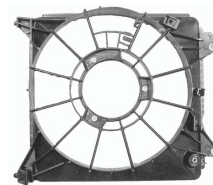

99732 / Corolla 1.8 09/18 C/ Ar

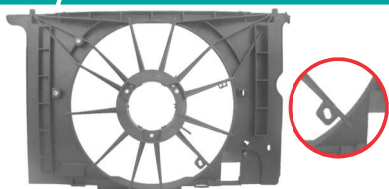

99733 / CRV 12/17
Condensador



99734 / CRV 12/17



99902 / UP MPI

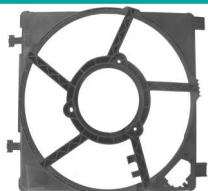

99904 / Uno Vivace
C/ Ar Similar Valeo

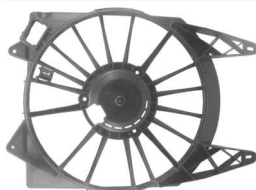

99941 / Cobalt/Onix/Novo Prisma
2017 Automático



99942 / Cobalt/Onix/Novo
Prisma 2017 Manual

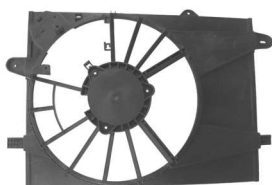

99943 / Logan / Sandero 1.0 8v
14/16



99973 / Jeep Compass 2017>



90001 / Doblo 1.3/1.8 02/09
C/ Ar Similar Denso

90002 / Doblo 1.4 10/20
C/ Ar Similar Denso

90013 / Fiesta Street 00/04

90014 / Ka Endura 97/00 S/ Ar

90015 / Focus 2.0 16V 09/14

90018 / Meriva 1.4/1.8 02/05
C/ Ar

90039 / Fox / Crossfox / Polo 06/12
C/ Ar

90050 / Condensador Astra
Zafira / Vectra 99/09 C/ Ar

90051 / Condensador Vectra 97/05 C/ Ar

90078 / Ducato C/ Ar 00>

90087 / Escort Zetec

90099 / Condensador Corsa 1.0/1.8

90103 / Picasso Frontal C/ Ar

90104 / Picasso Funil C/ Ar

90133 / 206 S/ Ar

90135 / Sprinter 97-02

90136 / Sprinter CDI 02/12

90137 / Jetta/ A3/ Tiguan Turbo

90138 / Sprinter 310/312 97/02



90139 / Audi A4/A5/Q5
2009> Duplo

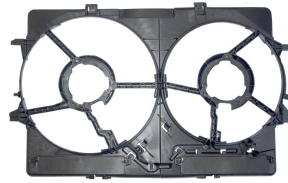

90140 / Picanto Sem
Reservatório 04/09



90519 / Berlingo
Partner 1998>



90756 / Hilux 2016>



90877 / I30 2013 / Cerato 2013



90878 / 307 / C4 Pallas 2002



90883 / Blazer Trail 3.6 2013

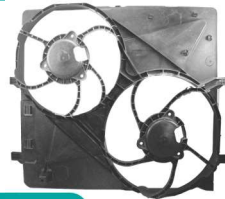

90884 / Jetta / Audi A3 / Tiguan
Passat 2.0T 2007

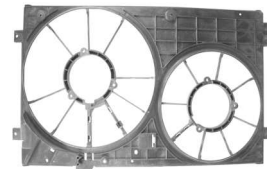

90886 / Scenic 99 C/ Ar

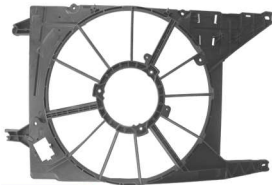

90887 / C3 Moderno 2001
Manual C/ Ar

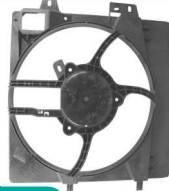

90888 / Clio 2000 C/ Ar



90892 / Santa Fé 2006 / 2009
C/ Ar Lado Motorista



90893 / Santa Fé 2006 / 2009
C/ Ar Lado Carona



90896 / Tucson 2.0 2005 Suporte
Baixo 06 C/ Ar

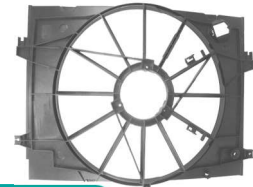

90897 / Santa Fé 2010> C/Ar

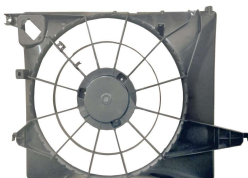

90898 / 206 / 207 C/ Ar
Frontal 2000

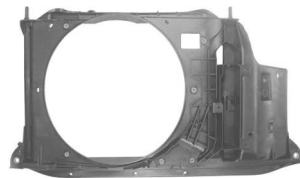

90901 / L200 Triton



90902 / Hilux Flex 05 / 06



90903 / Hilux Diesel 05 / 16



90906 / Etios 13



90907 / Doblo S/ Ar

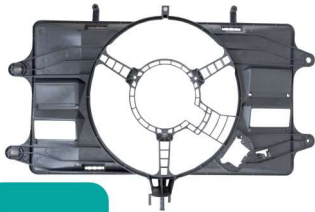

90909 / Virtus 19 / Polo 18 1.0 Turbo

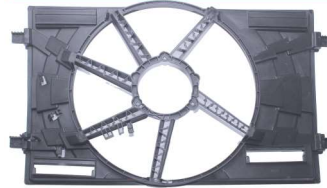

90910 / Toro / Renegade Diesel Duplo



90952 / C3 03 Frontal Manual

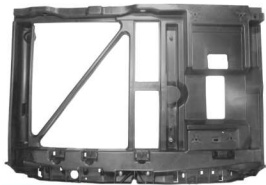

90953 / Azera 2008 / 2011 S/ Resistência

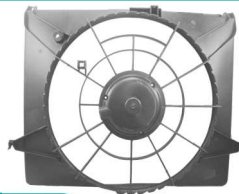

90960 / Accord 2.4 Lado Carona 2008

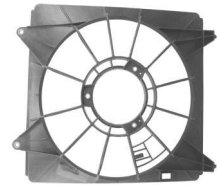

90961 / Cherokee Sport C/ Ar

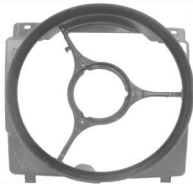

90962 / Civic Lado Carona C/ Ar

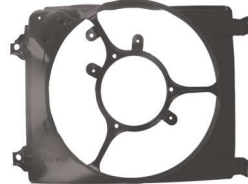

90963 / I30 10 C/ Ar

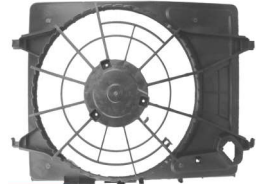

90964 / Mégane Grand Tour 06

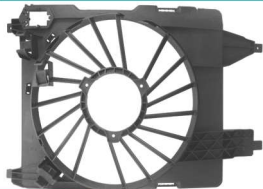

90965 / Picanto 2012> C/Reservatório

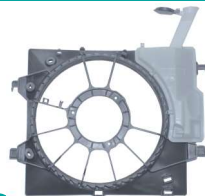

90966 / Picanto 2009 C/Reservatório



90967 / S10 2.4 2013> 1 motor



90970 / Tiida 2008 C/ Ar Todos



90971 / Soul 08

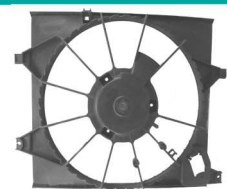

90973 / New Sorento 2010

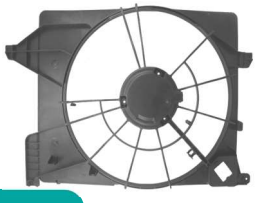

90974 / CRV 07/11
Lado Motorista



90975 / CRV 07/11
Lado Carona

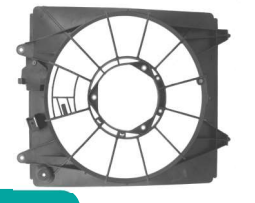

90976 / CRV 00 / 06
Lado Carona



90977 / CRV 2000/2006
Lado Motorista



90979 / Captiva 2008 C/ Ar Duplo

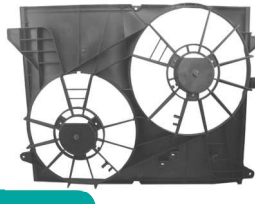

90980 / Tucson 2.0 2005
Suporte Alto

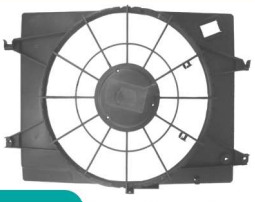

90983 / Tucson 2.7 05 / 11
Suporte Alto C/ Ar

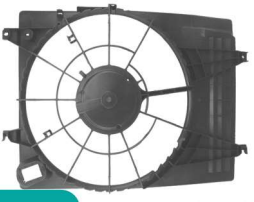

90984 / Focus 04 C/ Ar Duplo



90985 / Focus 1.6 Moderno
10 C/ Ar



90986 / KA Moderno 10
Fiesta Zetec Rocam



90987 / Golf / Bora / Fox
99 / 09 C/ Ar

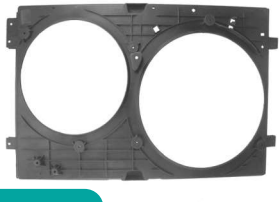

90992 / Tucson 2.7 05 >
Suporte Baixo

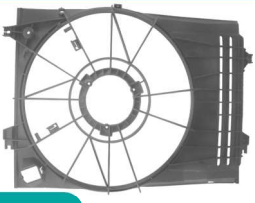

90993 / Ix35 / Tucson 10 C/ Ar



90994 / Corolla C/ Reservatório
Fielder C/ Ar

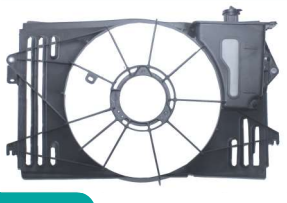

90989 / Duster 2012

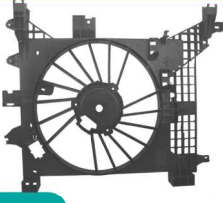

90995 / Corolla Até 01 C/ Ar



90999 / Civic 1.3 / 1.5 / 1.6
92 / 99



93000 / Frontier C/ Ar 03>



93001 / Argos 17> / Cronos 18>
Pulse 22>



93025 / Cruze 1.8 16V
11/16 Automático



95874 / Cerato 2010 / 2012
Reservatório

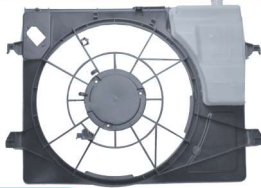

99781 / New Logan / New Sandero
2014 S/ Ar

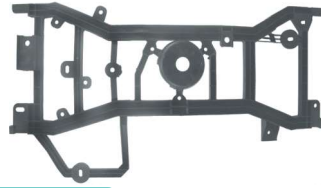

99905 / Uno Vivace / Palio
Siena Similar Valeo S/ Ar



99931 / Sentra 14>



99938 / Agile / Montana 2017 C/ Ar

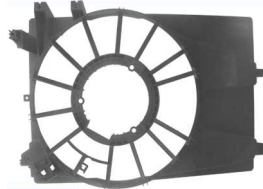

99939 / Civic Lado Carona
2001 / 2005

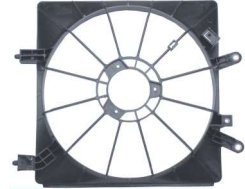

99944 / Kicks 2016>

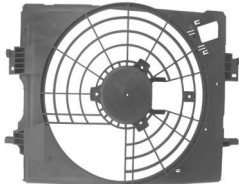

99945 / Civic Aspirado 16>



99946 / Civic Turbo 16>



99947 / Sentra Duplo 2008>



99948 / March/ Versa Até 13



99950 / ASX / Lancer 09>



99951 / Outlander 09 / 13



99952 / Outlander 14>



99953 / Airtrek 03 / 08



99954 / PT Cruizer 2006> C/ Ar



99955 / Grand Vitara 2008> Duplo



99956 / Volvo S60/S80/V60/XC60
XC70 2007> Evoque



99957 / Fusion 2.5/3.0 10/13



99958 / Fusion 2014> Duplo

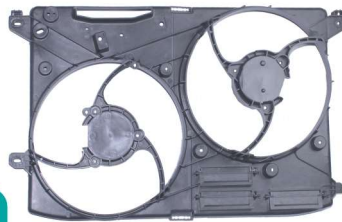

99959 / Ducato/ Jumper/ Boxer
18> Duplo

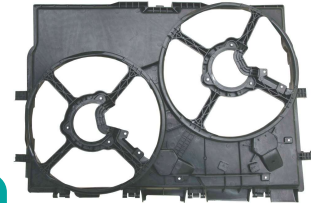

99960 / Scenic Logan AT 1999>

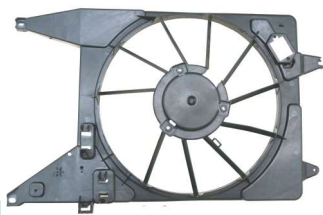

99961 / Ducato/Boxer/Jumper
99

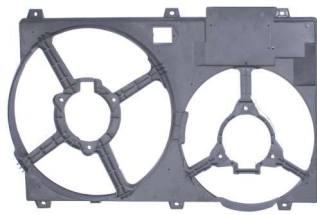

99962 / Civic 12>15

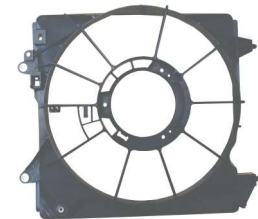

99963 / C3 / Aircross 11>



99965 / Master 14/19 2 Eletros



99966 / Accord 2,0 08>



99967 / Accord 2.4 08>

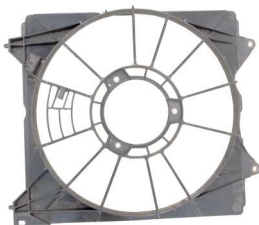

99968 / Audi A4 / Passat Alemão
Do Ar



99969 / Focus 1.6 / 2.0
14 / 19



99970 / Creta 2017>



99976 / Toyota Corolla 2020>



99977 / Air Cross
C3 2013 / 2017



99978 / Grade Corsa / Montana
03/09



99979 / Yaris 18 / 19

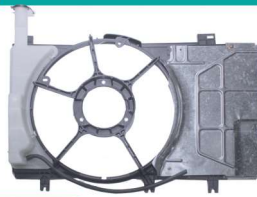

HÉLICES

90025 / Gol G2 / Escort

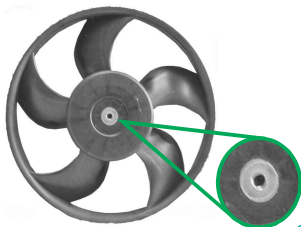

90026 / Palio Fire S/ Ar Similar Behr
Montana 7 Pás P

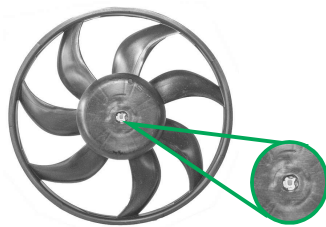

90027 / Gol G3 / G4

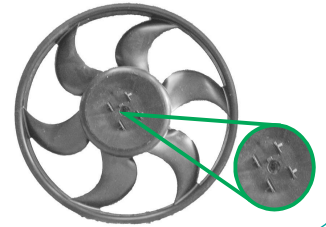

90029 / Fit 03/08 New Fit 09/14
City 11/14

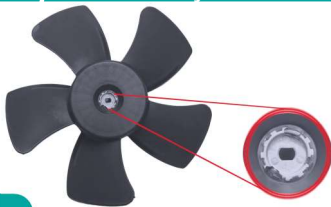

90042 / Gol G5 C/ Ar

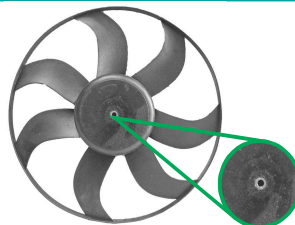

90043 / Palio Fire Similar Valeo
Celta/Prisma/Uno Fire 5 Pás

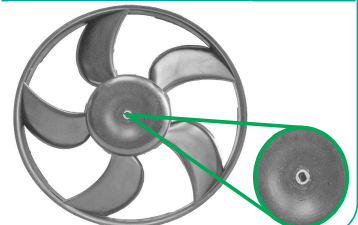

90044 / Palio 1.0 / 1.5 / Uno Antigo

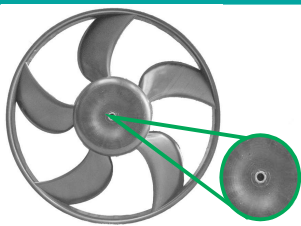

90046 / Palio Fire Similar Behr/ Peugeot 206/207
Montana/Doblò Antiga 03/07 7 Pás C/ Ar G

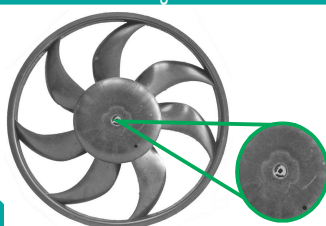

90047 / Condensador
Astra / Vectra P

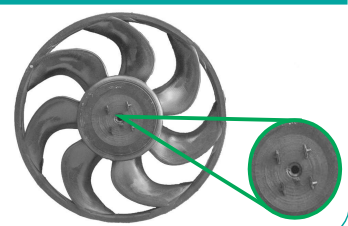

90052 / New March

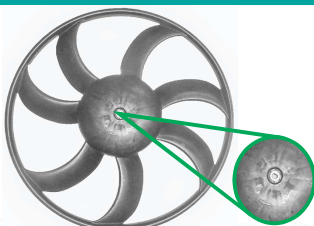

90054 / Astra / Vectra
Zafira / Meriva G

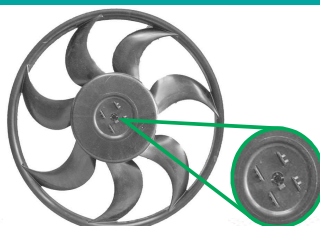

90055 / Celta Flex C/S/Ar 11 Pás

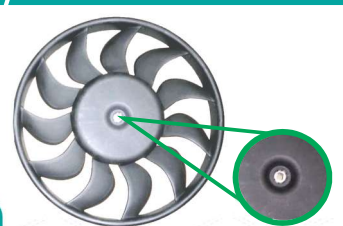

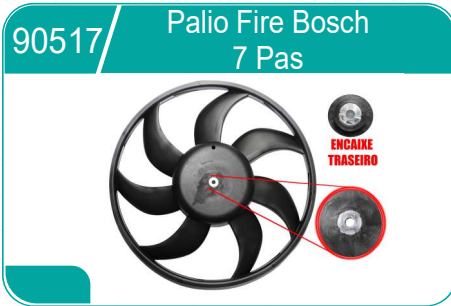
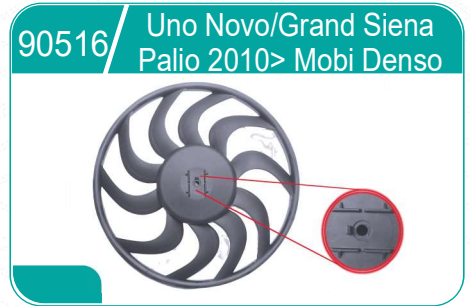
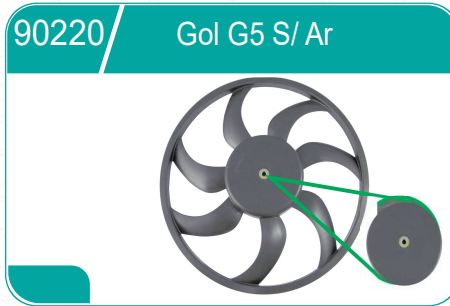
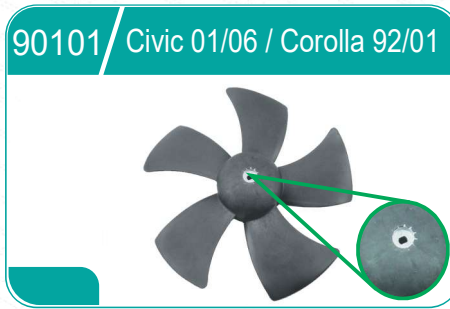
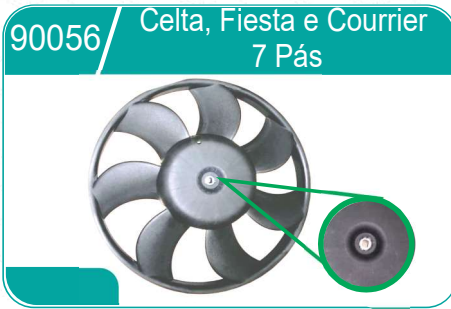

Motor C/ Hélice



GMV Completo

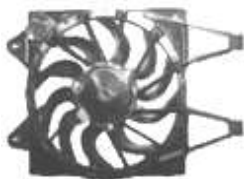

TRIPÉS

90040 / Fox



90041 / Golf / Audi P



90045 / Polo 2007



90950 / Fox / Polo >07
Space Fox



SUPORE E TORNEIRINHAS

1748 / Tampa P/ Reservatório
Água do Defletor Hb20 Novo



1755 / Tampa P/ Reservatório
Água do Defletor Hb20

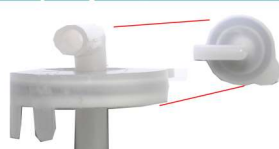

1858 / Tampão do Axor



1859 / Kit Tampão Sandero



1861 / Suporte do Radiador
Palio 1.0



1862 / Suporte do Radiador
Palio 1.5



1863 / Suporte do Radiador
Palio Adventure



1864 / Suporte do Radiador
Palio Weekend



1865/ Suporte do Radiador Palio Fire



1866/ Suporte do Radiador Fiorino/Spazio/Elba/Uno



1867/ Torneira P/ Sangrador Doblò / Marea Largo



1868/ Kit Linha Palio: 2 Calços e 3 Arruelas borracha P/ Defletor



1871/ Torneira P/ Sangrador Palio 1.5



1872/ Torneira P/ Sangrador Corolla 2009 P



1873/ Torneira P/ Sangrador Corolla 2009 G



1874/ Suporte Coxim do Gol G5



1875/ Sangrador Iveco Daily



1876/ Suporte do Radiador Idea Novo



1877/ Suporte Ecosport/Ka New Fiesta

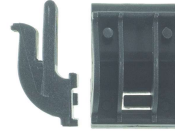

1878/ Tampão P/ Retorno do Fiesta

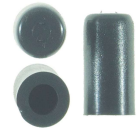

1882/ Torneira P/ Sangrador Marea



1883/ Torneira P/ Sangrador Honda



1887/ Retorno d'água Scania



1888/ Torneira P/ Sangrador Palio Fire Sim. Visconde



1889/ Torneira P/ Sangrador Gol/Palio Similar Valeo



1894/ Tampão Scania



1895/ Suporte do Radiador Uno Fire



1908/ Kit Tampão Peugeot CHT 19



1915/ Tampão DAF



4000/ Suporte do Radiador 01 Similar Behr



4001/ Suporte do Radiador 02 Similar Behr



4002/ Suporte do Radiador 03 Similar Behr



4003/ Suporte do Radiador 04 Similar Behr



4004/ Torneira P/ Sangrador Iveco Eurocargo/Focus



5001/ Retorno Peugeot



5002/ Torneira P/ Sangrador Iveco Strallis



5003/ Torneira P/ Sangrador Mercedes Benz 0500



5004/ Torneira P/ Sangrador Captiva/Cruze P



5005/ Torneira P/ Sangrador Capitiva/Cruze G



5006/ Torneira P/ Sangrador Accelo



5007/ Torneira P/ Sangrador Spin/Cobalt/Onix P



5008/ Torneira P/ Sangrador Spin/Cobalt/Onix G



5009/ Torneira P/ Sangrador Caterpillar/ Case



5012/ Suporte Superior Esq. Montana / Corsa Novo



5013/ Suporte Superior Esq. Corsa Classic 94/17



5014/ Suporte Superior Prisma 06/12 Celta 01/16



5015/ Suporte Superior Dir. Vectra 97/05



5016/ Suporte Superior Dir. Corsa Classic 94/17



5017/ Suporte Superior Esq. Vectra 97/05



5018/ Suporte Inferior Astra 99/11 Zafira 01/12



5019/ Suporte Superior Dir. Corsa Classic 94/17 S/Ar



5020/ Kit Torneirinha BMW X1 116l/118l/120l/130l/316l>04



5021/ Suporte Superior Dir. Montana/Corsa/Meriva



5022/ Suporte Superior Esq. Montana/Corsa/Meriva



5023/ Suporte Superior Montana 11/21 Agile 10/14



5024/ Coxim Superior Suporte Montana/Meriva/Corsa



5025/ Tampão Scania Série 7



5026/ Retorno Scania Série 7



5027/ Torneirinha Original P/ Sang. Cobalt/Onix P



5028/ Torneirinha Original P/ Sang. Cobalt/Onix G



5032/ Torneirinha P/ Sangrador Uno Vivace P



5033/ Torneirinha P/ Sangrador Uno Vivace G



RESERVATÓRIO DE EXPANSÃO - FLÓRIO

TRABALHAMOS COM RESERVATÓRIOS DE EXPANSÃO DE DIVERSOS OS MODELOS

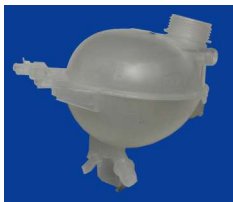

CONSULTE-NOS

TAMPAS DE RADIADOR IMPORTADA



3650



3640



3670



3660

TAMPAS DE RADIADORES E RESERVATÓRIO DE EXPANSÃO



TRABALHAMOS COM TAMPAS DE RADIADORES E RESERVATÓRIOS DE EXPANSÃO DIVERSOS MODELOS

CONSULTE-NOS

ACESSÓRIOS

Porca



Trava hélice



Kit punção



CORDÕES DE VEDAÇÃO

- 1499 Esponjoso redondo 4mm
- 1500 Esponjoso redondo 5mm
- 1510 Esponjoso redondo 6mm
- 1520 Esponjoso redondo 8mm
- 1525 Rígido redondo 5mm
- 1529 Rígido 3 x 5mm
- 1530 Rígido 4 x 5mm
- 1531 Esponjoso 6 x 4mm
- 1532 Esponjoso 3mm
- 1550 Rígido 6 x 3mm

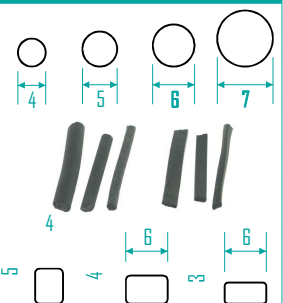

ABRAÇADEIRAS SUPRENS

- 2429 PAB 22 x 32 - fita 9mm - pct. c/ 10
- 2430 PAB 25 x 38 - fita 9mm - pct. c/ 10
- 2431 PAB 89 x 108 - fita 9mm - pct. c/ 10
- 2432 PAB 32 x 44 - fita 9mm - pct. c/ 10
- 2433 PAB 32 x 44 - fita 14mm - pct. c/ 10
- 2434 PAB 38 x 51 - fita 9mm - pct. c/ 10
- 2436 PAB 44 x 57 - fita 9mm - pct. c/ 10
- 2438 PAB 51 x 64 - fita 9mm - pct. c/ 10
- 2440 PAB 57 x 76 - fita 9mm - pct. c/ 10
- 2442 FAB 13 x 19 - fita 14mm - pct. c/ 10
- 2443 FAB 19 x 27 - fita 14mm - pct. c/ 10
- 2444 FAB 25 x 38 - fita 14mm - pct. c/ 10
- 2446 FAB 38 x 51 - fita 14mm - pct. c/ 10
- 2448 FAB 44 x 57 - fita 14mm - pct. c/ 10
- 2450 FAB 57 x 76 - fita 14mm - pct. c/ 10
- 2451 FAB 51 x 64 - fita 14mm - pct. c/ 10
- 2452 FAB 70 x 89 - fita 14mm - pct. c/ 10
- 2454 FAB 102 x 121 - fita 14mm - pct. c/ 10
- 2456 FAB 114 x 133 - fita 14mm - pct. c/ 10
- 2458 MAB 9 x 13 - micro - pct. c/ 10
- 2459 MAB 19 x 27 - micro - pct. c/ 10
- 2460 MAB 12 x 16 - micro - pct. c/ 10
- 2461 MAB 22 x 32 - micro - pct. c/ 10
- 2462 MAB 13 x 19 - micro - pct. c/ 10
- 2463 MAB 14 x 22 - micro - pct. c/ 10
- 2464 FIF 70 x 89 - inox 14mm - pct. c/ 5
- 2466 FIF 83 x 102 - inox 14mm - pct. c/ 5
- 2468 FIF 114 x 133 - inox 14mm - pct. c/ 5
- 2469 Abraçadeira de Nylon 4,8x300mm pct c/100
- 2470 TUCHO 57 x 65 - inox - pct. c/ 2
- 2472 TUCHO 68 x 77 - inox - pct. c/ 2
- 2473 TUCHO 74 x 83 - inox - pct. c/ 2
- 2474 TUCHO 80 x 89 - inox - pct. c/ 2



BORRACHAS DE VEDAÇÃO

- 1200 Apollo e Verona
- 1210 Corcel e Escort
- 1220 Corsa
- 1230 Fiat 147
- 1240 Gol e Passat
- 1241 Gol e Passat p/ radiador visconde
- 1250 Gol bola
- 1260 Intercooler
- 1270 Kadett
- 1280 Monza
- 1290 Opala e Chevette
- 1300 Palio 1.0
- 1310 Palio 1.5
- 1320 Palio Fire / Peugeot e Renault
- 1330 S10
- 1340 Santana
- 1345 Prisma / Ecosport
- 1350 Uno
- 1355 Celta Prisma
- 1371 Corsa Montana
- 1372 Gol G5



2258-FIXADOR DE TANQUE DO RADIADOR (SARGENTO)



2701 - KIT ALICATE AB/FEC



ACESSE NOSSO SITE

ANEL DE VEDAÇÃO

- 1308 Scania Serie 7 G - 1030mm x 60mm
- 1309 Scania Serie 7 P - 750mm x 60mm
- 1311 S10 2013 C/ Retorno - 656mm x 48mm
- 1360 Astra / Zafira - 390mm x 40mm
- 1361 Zafira / Vectra Novo - 395mm x 55mm
- 1362 Astra 2010 Fino - 389mm x 32mm
- 1363 Valtra - 570mm x 125mm
- 1364 Ford Cargo Curto - 575mm x 77mm
- 1365 Scania Série 6 P - 960mm x 59mm
- 1366 HR - 590mm x 58mm
- 1367 Vectra/Zafira/Astra C/ Orelha - 390mm x 40mm
- 1368 Astra/Zafira 26 - C/ Orelha -
- 1369 Valtra C/ Orelha - 530mm x 124mm
- 1370 Corsa - 275mm x 45mm
- 1373 Valtra C/ Orelha - 640mm x 120mm
- 1374 Actros - 839mm x 70mm
- 1376 Scania Serie 6 M - 1000mm x 59mm
- 1377 Scania Serie 6 G - 1075mm x 59mm
- 1379 Ateção - 776mm x 75
- 1380 Uno LX - Argentino - 322mm x 47mm
- 1381 FH Nova - 911mm x 70mm
- 1382 Man TGX - 964mm x 73mm
- 1383 Acello - 497mm x 77mm
- 1390 Fiesta, Ka e Ecosport - 378mm x 50mm
- 1400 Ford Corcel / Escort - 313mm x 48mm
- 1410 Ka / Focus - Brazado - 365mm x 45mm
- 1420 Gol bola c/ ar - 325mm x 58mm
- 1421 Gol bola canelado c/ ar - 330mm x 50mm
- 1422 Palio Fire Similar RV - 390mm x 41mm
- 1424 O-500 - 655mm x 90mm
- 1425 Cargo Grande - 644mm x 76mm 
- 1426 Corolla fino - 657mm x 31mm 
- 1427 Volvo VM - 595mm x 71mm
- 1428 Scania 124 Série 5 G - 1025mm x 59mm
- 1429 Civic - 370mm x 32mm
- 1430 Volvo FMX - 749mm x 70mm
- 1435 Volvo FH 12 - 910mm x 80mm
- 1436 MB Axor - 680mm x 85mm
- 1438 VW Constellation - 670mm x 77mm
- 1445 MB - 1721 / 1620 - 636mm x 73mm
- 1446 MB O-400 - 720mm x 68mm
- 1447 Scania 124 série 4 - 910mm x 77mm
- 1448 Scania P 94 - 700mm x 55mm
- 1450 Monza e Kadett - Brazado - 420mm x 44mm
- 1451 Peugeot 206 - 555mm x 42mm
- 1452 Scania 124 série 5 P - 704mm x 56mm
- 1453 Scania 124 série 5 M - 940mm x 56mm
- 1460 MB Sprinter - 424mm x 56mm
- 1470 Tempra - 355mm x 47mm
- 1480 Tipo - 380mm x 47mm
- 1490 Vectra / Meriva - 372mm x 53mm
- 1491 MB 709 / 912 - 433mm x 60mm
- 1492 MB 1418 / O-366 - 632mm x 73mm
- 1497 Volvo FM - 737mm x 73mm 
- 1498 Iveco Stralis - 766mm x 68mm 
- 1501 Mercedes - 690mm x 80mm
- 1502 Renault Kwid - 365mm x 34mm
- 1503 Caterpillar - 730mm x 124mm
- 1504 John Deere - 544mm x 105mm
- 1505 Iveco Eurocargo Tector Behr - 581mm x 60mm
- 1506 New Civic / Marea - 698mm x 47mm
- 1507 C3 / Onix Novo - 378mm x 32mm
- 1508 Daf XF 105 - 775mm x 72mm
- 1509 O500 - 656mm x 92mm

ANEL DE VEDAÇÃO

- 1511 Iveco Daily 2013 - 627mm x 52mm
- 1512 Scania Serie 7 M - 850mm x 60mm
- 1513 Massey Ferguson - 510mm x 110mm
- 1514 Corolla - 657mm x 31mm
- 1515 John Deere 6000 - 510mm x 109mm
- 1516 Case MX 180 C/ Tampa - 545x 144mm
- 1517 Iveco Eurocargo Tector Valeo - 600mm x 59mm
- 1518 Atego - 582mm x 60mm
- 1519 Mercedes 1634 - 715mm x 73mm
- 1522 VW 8-160 - 612mm x 85mm
- 1523 Constellation - 680mm x 85mm
- 1524 Corolla 2003 - 427mm x 48mm

CONEXÕES E ADAPTADORES

- 2219 Conexão ASX / Outlander 
- 2223 Conexão Rápida Superior Radiador Fox 
- 2224 Conexão Rápida Rad. Golf A4/Fox/Bora 
- 2225 Conexão Rápida Rad. Audi A3 
- 2228 Conexão Capa Preta Reto 
- 2229 Conexão Cinza 90/5/16 
- 2231 Conexão Cinza Reto 5/16 
- 2232 Conexão L-200 Triton/Pajero Dakar 
- 2233 Conexão de para Rad c/7pçs
- 2234 Conexão para Radiadores N°1 
- 2235 Conexão para Radiadores N°2 
- 2236 Conexão para Radiadores N°3 
- 2237 Conexão para Radiadores N°4 
- 2238 Conexão para Radiadores N°5 
- 2239 Conexão para Radiadores N°6 
- 2241 Conexão para Radiadores N°7 
- 2242 Engate Rápido do Uno Vivace 
- 2243 Conexão Fluxo Água Audi A3 Turbo 1.8 
- 2244 Plug Tampão do Reservatório do Radiador 
- 2245 Adaptador 90° bico Longo C/ Anel de Viton 
- 2246 Adaptador T - C/ Anel Viton 
- 2247 Adaptador Y - 6mm S/ Anel 
- 2248 Adaptador Reto Bico Longo C/ Anel Viton 
- 2249 Conexão Água Ar Quente - Audi A3 98/06 
- 2251 Conexão Água Ar Quente - Audi A3 00/06 
- 2252 Flange Válvula Termostática - Passat / Golf 
- 2253 Cotovelo de Saída de Água Fox / Polo 
- 2254 Conexão Y P/ Mangueira - Golf / A4 1.6 
- 2255 Conexão Fluxo Água - Golf / Audi / A4 
- 2256 Conexão Fluxo Água - Polo Sedan / Cordoba 
- 2259 Conector de Fluxo de Água 
- 2261 Flange C/ Anel Vedação 
- 2262 Flange Fluxo Água Golf / Audi A4 
- 2266 Conexão Emenda Mangueira N°8 
- 2267 Conexão Emenda Mangueira N°9 
- 2268 Conexão Emenda Mangueira N°10
- 2269 Conexão Engate Rápido do Strallis
- 2272 Conexão L-200 Triton Bocal Reto - 20mm
- 2273 Conexão Hb20 1.0
- 2274 Conexão Hb20 1.6
- 2275 Conexão Civic
- 2276 Conexão Triplo Corolla 08/15
- 2277 Conexão Iveco Daily Euro 3.0
- 2278 Conexão Engate Rápido Inferior Iveco
- 2279 Conexão L-200 Triton Bocal Reto - 25mm
- 2281 Conexão Freemont / Journey

TAMPÃO DE TESTES

- 2008 Nº 5 fechado - S18 I14 A25 / 2019 aberto
- 2009 Nº 6 fechado - S21 I17 A28 / 2021 aberto
- 2011 Nº 7 fechado - S23 I18 A28/ 2022 aberto
- 2100 Nº 8 fechado - S26 I21 A32 / 2023 aberto
- 2110 Nº 9 fechado - S30 I25 A30 / 2024 aberto
- 2120 Nº 10 fechado - S33 I27 A38 / 2025 aberto
- 2130 Nº 11 fechado - S36 I30 A39 / 2026 aberto
- 2140 Nº 12 fechado - S40 I32 A43 / 2027 aberto
- 2150 Nº 13 fechado - S43 I37 A45 / 2028 aberto
- 2160 Nº 14 fechado - S52 I45 A52 / 2029 aberto
- 2170 Nº 15 fechado - S55 I45 A57 / 2036 aberto
- 2180 Nº 16 fechado - S61 I52 A60 / 2031 aberto
- 2016 Nº 17 fechado - S71 I62 A67 / 2032 aberto
- 2190 Nº 18 fechado - S69 I58 A64 / 2033 aberto
- 2200 Nº 19 fechado - S76 I65 A73 / 2034 aberto
- 2210 Nº 20 fechado - S90 I78 A71 / 2035 aberto
- 2220 Nº 21 fechado S105 I94 A75 / 2037 aberto



COXIM DO RADIADOR

- 1820 Coxim do Radiador: 1111, 1113, 1313, 2013, 2213, 2215, 2513 | Pct. c/ 2 Pçs.
- 1823 Coxim G5 / Fox / Voyage - Pct C/ 4 Pçs.
- 1824 Coxim Uno Inferior - Pct C/ 4 Pçs.
- 1830 Coxim Superior do Radiador: 608-D | Pct. c/ 10 Pçs.
- 1835 Coxim do Radiador Pequeno: Passat
- 1840 Coxim Inferior do Radiador: 608-D | Pct. c/ 10 Pçs.
- 1841 Coxim Inferior do Radiador: Chevette 73/93, Chevy 84/95, Marajó 81/89
- 1842 Coxim Inferior do Radiador: Caravan 74/92, Chevette 73/93, Chevy 84/95, Marajó 81/89, Opala 62/92
Pct. c/ 10 Pçs.
- 1843 Coxim inferior do Radiador: A-C-D-10 67 / 84 , A-C-14 85/89 Pct. C/10 Pçs
- 1844 Coxim Palio Inferior Pct. c/ 4 Pçs.
- 1850 Coxim do Radiador Pequeno: Passat / Royale / Versailles 91
- 1860 Coxim do Radiador Grande: Passat / Royale / Versailles 91



BOCAIS

- 1869 Boquilha de Latão - Mercedes
- 1870 Boquilha de Latão - P/ Importados
- 1880 Boquilha de latão - Universal
- 1885 Boquilha de Alumínio - P/ Importados
- 1886 Boquilha de Alumínio - Universal
- 1891 Mangueira Metal Superior 1113
- 1892 Mangueira Metal Inferior 1113
- 1893 Tubo do Bocal Metal 1113



ESCOVAS

- 1910 Escova C/ Cabo de Madeira, 3 Fileiras
- 1911 Escova C/ Cabo de Madeira, 4 Fileiras
- 1920 Escova de Aço S/ Cabo
- 1921 Escova de Aço C/ Cabo Plástico

Caixa Com 12 Unidades



GRAMPOS E TAMPÕES

- 1884 Anel do Tampão de Cebolão - Pct. C/10 (Papelão)
- 1899 Anel do Tampão de Cebolão - Pct. C/10 (Borracha)
- 1930 Grampo - Pct. C/10
- 1940 Tampão Cebolão - Pct. C/10



SOLDAS DE ESTANHOS

- 2010 Solda 30 x 70
- 2020 Solda 40 x 60
- 2030 Solda 50 x 50
- 2040 Estanho Virgem
- 2050 Lingote de Chumbo



FLUXOS

- 2060 Cloreto de Zinco Bomba Com 7,5 Kg
- 2063 Gel Para Hélice Viscosa 5 Litros
- 2065 Cloreto de Zinco Bomba de 60 Kg
- 2097 Limpa Baú BB 20 Litros
- 2098 Limpa Baú 5 Litros
- 2106 Gel Para Hélice Viscosa 1 Litro



ADITIVOS SS

- 2090 Aditivo SSfluid Concentrado Verde
- 2091 Aditivo SSFluid Concentrado Rosa
- 2096 Aditivo SSRad Rosa
- 2101 Aditivo SSRad Verde
- 2102 Aditivo SSRad Azul
- 2103 Aditivo SSRad Amarelo
- 2105 Água Desmineralizada SS
- 2108 Aditivo SSFluid Concentrado Azul
- 2111 Aditivo SSRad Rosa galão 5L
- 2112 Aditivo SSRad Verde galão 5L
- 2113 Aditivo SSRad Azul galão 5L
- 2115 Aditivo SSRad Amarelo galão 5L
- 2116 Água BI-Desmineralizada SS galão 5L



MAÇARICO E ACESSÓRIOS

- 3000 Maçarico - Iron
- 3020 Bico Nº1 - Iron
- 3030 Bico Nº2 - Iron
- 3040 Bico Nº3 - Iron
- 3050 Ponteira de Cobre - Iron



TINTAS

- 1890 Lata Com 3,6 Litros - Cor Preta
- 1900 Lata Com 18 Litros - Cor Preta
- 1901 Lata Com 3,6 Litros Caterpillar - Cor Amarelo Peq.
- 1902 Lata Com 18 Litros Caterpillar - Cor Amarelo Grd.
- 1903 Lata Com 3,6 Caterpillar - Cor Alumínio
- 1904 Lata Com 18 Litros - Cor Alumínio



ADITIVOS SS / DIVERSOS



1 LITRO

SS

RADNAQ



5 LITROS

KIT PARA TESTE INTERCOOLER/RADIADOR



COD:2221



COD:2222



COD:2226



COD:2265

SOLDAS ESPECIAIS

- 1950 Aluminex pó - 200g
- 1951 Aluminex SS pó - 200g
- 1952 Fluxo de prata - 250g
- 1953 Trincal Fluxo Oxi-Acetileno - 250g
- 1960 Aluminex Past - 200g
- 1961 Poly Plus (Pó) - 935g
- 1962 Poly Plus (Resina) - 1030g
- 1964 Vareta Foscooper S/ Prata (Uniweld) (Kg)
- 1965 Vareta Latão P/ Solda Amarelo (Uniweld) (Kg)
- 1966 Fluxo P/ Vareta de Latão (Uniweld) - 100g
- 1967 Aluminex Fluxo P/ Vareta (Uniweld) - 200g
- 1968 Solda Cobix Pasta - 110g
- 1970 Poly Plus Kit - 1.965g
- 1973 Poly Plus Kit - 195g
- 1974 ADS-20 Araldite Industrial 24h - Conj - 900g
- 1975 ADS-20 Araldite Industrial 24h - Conj - 400g
- 1976 ADS-22 Araldite Rápido 10m - Conj - 500g
- 1980 Tubolit Cola 301 - 1000g
- 1981 Poly Plus (Resina) - 90g
- 1996 Tinex Fluxo Para Solda - 300g
- 1998 Vareta Izi Migrare 1 (Unidade)
- 1999 Vareta Silício 40/47 12% Ox 12 1/8 (Grossa) (Kg)
- 2000 Vareta Silício 40/47 12% Ox 12 3/32 (Fina) (Kg)
- 2001 Trincalox - 250g
- 2002 Foscooper Com Prata (Kg)
- 2003 Vareta Silicio - 40/43 2,4 (Kg)
- 2007 Aron para Solda Foscooper Latão - 200g
- 2012 Vareta SS100 - P/ Evaporadores + Rad. de Alum. (Kg)
- 2013 Vareta SS500 - P/ Soldar Alumínio, Latão e Cobre (Kg)
- 2014 Fluxo Essen AG Flux - 100g
- 2015 Solda Alumax-C - 71g
- 2018 Vareta Izi Migrare 7 (Unidade)



RADIADORES E COLMEIAS



Consulte

RADIADORES DE ÓLEO



80197 HR

INTERCOOLER

40026 /

Kia Bongo



80189 /

HR



50801 /

1620



50805 /

Scania Serie 7 Medio



70070 /

Scania 112 / 113



70071 /

Constellation 24250



70072 /

Iveco / Eurocargo



70075 /

Beta Moderno



70087 /

Constellation 13180



CAIXAS DE LATÃO, KITS E LATERAIS



4101- MB14171



4031- MB30255



4021- MB300114

CAIXAS DE INTERCOOLER



9209 MBB Atego superior - 3407



9210 MBB Atego inferior - 3731



9236 Iveco Tractor / Eurocargo (LD) - 3803



9235 Iveco Tractor / Eurocargo (LE) - 3802



9233 MBB Axor superior Behr - 3804



9234 MBB Axor inferior Behr - 3805



9237 MBB Axor superior Valeo - 3808



9238 MBB Axor inferior Valeo - 3807



9208 MBB Sprinter - 3444